

Feel Yourself a Student!

Dear friends, I would like to give to you an interesting and reliable antenna theory. Hours searching in the web gave me lots theoretical information about antennas. Really, at first I did not know what information to chose for ANTENTOP. Finally, I stopped on lectures “Modern Antennas in Wireless Telecommunications” written by Prof. Natalia K. Nikolova from McMaster University, Hamilton, Canada.

You ask me: Why?

Well, I have read many textbooks on Antennas, both, as in Russian as in English. So, I have the possibility to compare different textbook, and I think, that the lectures give knowledge in antenna field in great way. Here first lecture “Introduction into Antenna Study” is here. Next issues of ANTENTOP will contain some other lectures.

So, feel yourself a student! Go to Antenna Studies!

I.G.

My Friends, the above placed Intro was given at ANTENTOP- 01- 2003 to Antennas Lectures.

Now I know, that the Lecture is one of popular topics of ANTENTOP. Every Antenna Lecture was downloaded more than 1000 times!

*Now I want to present to you one more very interesting Lecture - it is a Lecture **Linear Wire Antennas – Dipoles and Monopoles**. I believe, you cannot find such info anywhere for free! Very interesting and very useful info for every ham, for every radio- engineer.*

So, feel yourself a student! Go to Antenna Studies!

I.G.

McMaster University Hall

Prof. Natalia K. Nikolova

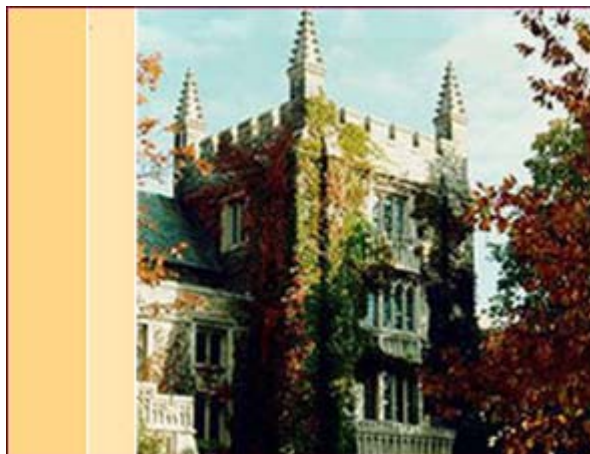

Linear Wire Antennas – Dipoles and Monopoles

Small electric dipole antenna. Finite-length dipoles. Half-wavelength dipole. Method of images - revision. Vertical infinitesimal dipole above a conducting plane. Monopoles. Horizontal infinitesimal dipole above a conducting plane.

by Prof. Natalia K. Nikolova

Lecture 8: Linear Wire Antennas – Dipoles and Monopoles

(Small electric dipole antenna. Finite-length dipoles. Half-wavelength dipole. Method of images - revision. Vertical infinitesimal dipole above a conducting plane. Monopoles. Horizontal infinitesimal dipole above a conducting plane.)

The dipole and the monopole are two most widely used antennas for wireless mobile communication systems. Arrays of dipoles are commonly used as base-station antennas in land-mobile systems. The monopole is perhaps the most common antenna for portable equipment, such as cellular telephones, cordless telephones, automobiles, trains, etc. It has attractive features such as simple construction, relatively broadband characteristics, small dimensions at high frequencies. An alternative to the monopole antenna for hand-held units is the loop antenna, the microstrip patch antenna, the spiral antennas, and others.

1. Small dipole

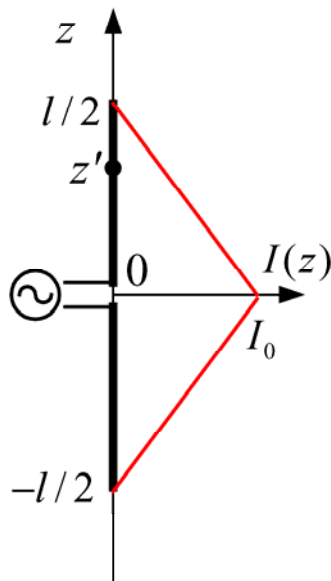

$$\frac{\lambda}{50} < l \leq \frac{\lambda}{10} \tag{8.1}$$

If one assumes that $R \approx r$ and condition (8.1) holds, the maximum phase error in (βR) that can occur is

$$e_{\max} = \frac{\beta l}{2} = \frac{\pi}{10} \approx 18^\circ,$$

at $\theta = 0^\circ$. *Reminder:* a maximum total phase error of $\pi/8$ is acceptable since it does not affect substantially the integral solution for \vec{A} . The assumption $R \approx r$ will be made for both, the amplitude and the phase factors in the kernel of the VP integral.

The current is a triangular function of z' :

$$I(z') = \begin{cases} I_0 \cdot \left(1 - \frac{z'}{l/2}\right), & 0 \leq z' \leq l/2 \\ I_0 \cdot \left(1 + \frac{z'}{l/2}\right), & -l/2 \leq z' \leq 0 \end{cases} \quad (8.2)$$

The VP integral is obtained as:

$$\vec{A} = \hat{z} \cdot \frac{\mu}{4\pi} \left[\int_{-l/2}^0 I_0 \left(1 + \frac{z'}{l/2}\right) \frac{e^{-j\beta R}}{R} dz' + \int_0^{l/2} I_0 \left(1 - \frac{z'}{l/2}\right) \frac{e^{-j\beta R}}{R} dz' \right] \quad (8.3)$$

The solution of (8.3) is particularly simple when it can be assumed that $R \approx r$:

$$\vec{A} = \hat{z} \cdot \frac{1}{2} \left[\frac{\mu}{4\pi} I_0 l \frac{e^{-j\beta r}}{r} \right] \quad (8.4)$$

The further away from the antenna the observation point is, the more accurate the expression in (8.4). Note that *the result in (8.4) is exactly one-half of the result obtained for \vec{A} of an infinitesimal dipole*, if I_0 were the current uniformly distributed along the dipole. This is to be expected because we made the same approximation for R , as in the case of the infinitesimal dipole with a constant current distribution, and we integrated a triangular function along l , whose average is obviously $\frac{1}{2} I_0$.

Therefore, we need not repeat all the calculations of the field components, power and antenna parameters. We shall make use of our knowledge of the infinitesimal dipole field. The far-field components of the small dipole are simply half those of the infinitesimal dipole:

$$\begin{aligned} E_\theta &\approx j\eta \frac{\beta I_0 l}{8\pi} \frac{e^{-j\beta r}}{r} \sin \theta \\ H_\phi &\approx j \frac{\beta I_0 l}{8\pi} \frac{e^{-j\beta r}}{r} \sin \theta, \quad \beta r \gg 1 \\ E_r = E_\phi = H_r = H_\theta &= 0 \end{aligned} \quad (8.5)$$

The normalized field pattern is the same as that of the infinitesimal dipole:

$$\bar{E}(\theta, \varphi) = \sin \theta \quad (8.6)$$

The power pattern:

$$\bar{U}(\theta, \varphi) = \sin^2 \theta \quad (8.7)$$

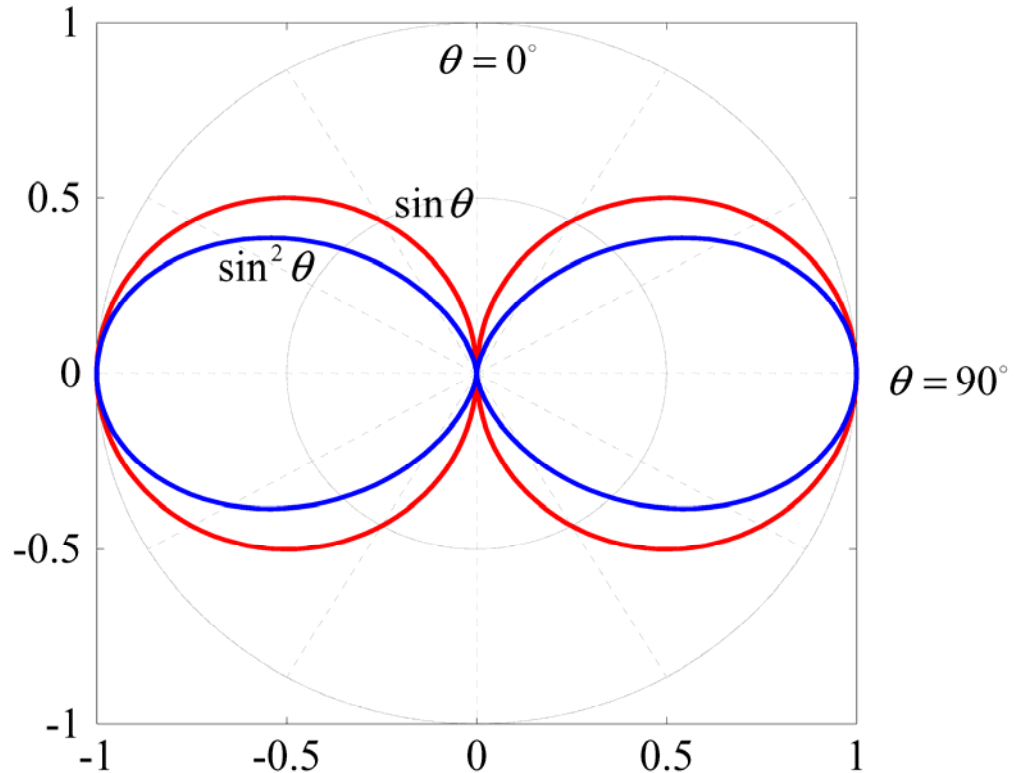

The beam solid angle:

$$\Omega_A = \int_0^{2\pi} \int_0^{\pi} \sin^2 \theta \cdot \sin \theta d\theta d\varphi$$

$$\Omega_A = 2\pi \cdot \int_0^{\pi} \sin^3 \theta d\theta = 2\pi \cdot \frac{4}{3} = \frac{8\pi}{3}$$

The directivity:

$$D_0 = \frac{4\pi}{\Omega_A} = \frac{3}{2} = 1.5 \quad (8.8)$$

As expected, the directivity (and the beam solid angle, as well as the effective aperture) is the same as those of the infinitesimal dipole, because the normalized patterns of both dipoles are the same.

The radiated power will be four times less than that of an infinitesimal dipole because the far fields are twice less:

$$\Pi_{rad} = \frac{1}{4} \cdot \frac{\pi}{3} \eta \left(\frac{I_0 \Delta l}{\lambda} \right)^2 = \frac{\pi}{12} \eta \left(\frac{I_0 \Delta l}{\lambda} \right)^2 \quad (8.9)$$

As a result, the radiation resistance is also four times less compared to that of the infinitesimal dipole:

$$R_r = \frac{\pi}{6} \eta \left(\frac{\Delta l}{\lambda} \right)^2 = 20\pi^2 \left(\frac{\Delta l}{\lambda} \right)^2 \quad (8.10)$$

2. Finite-length infinitesimally thin dipole

A good approximation of the current distribution along the dipole's length is the sinusoidal one:

$$I(z') = \begin{cases} I_0 \sin \left[\beta \left(\frac{l}{2} - z' \right) \right], & 0 \leq z' \leq l/2 \\ I_0 \sin \left[\beta \left(\frac{l}{2} + z' \right) \right], & -l/2 \leq z' \leq 0 \end{cases} \quad (8.11)$$

It can be shown that the VP integral

$$\vec{A} = \hat{z} \cdot \frac{\mu}{4\pi} \int_{-l/2}^{l/2} I(z') \frac{e^{-j\beta R}}{R} dz' \quad (8.12)$$

has an analytical (closed form) solution. Nevertheless, we shall follow a standard approach commonly used to calculate the far field. It is based on the solution to the infinitesimal dipole field problem. The finite-length dipole is subdivided into an infinite number of infinitesimal dipoles of length dz' . Each infinitesimal dipole produces the elementary far field described as:

$$\begin{aligned} dE_\theta &\approx j\eta\beta I_{e(z')} \frac{e^{-j\beta r}}{4\pi r} \sin\theta \cdot dz' \\ dH_\varphi &\approx j\beta I_{e(z')} \frac{e^{-j\beta r}}{4\pi r} \sin\theta \cdot dz' \\ dE_r &= dE_\varphi = dH_r = dH_\theta = 0 \end{aligned} \quad (8.13)$$

Here, $I_{e(z)}$ denotes the current value of the current element at z' . Using the far-zone approximations:

$$\left| \begin{array}{l} \frac{1}{R} \simeq \frac{1}{r}, \text{ for the amplitude factor} \\ R \simeq r - z' \cos \theta, \text{ for the phase factor} \end{array} \right. \quad (8.14)$$

the following approximation of the elementary far field is obtained:

$$dE_{\theta} \simeq j\eta\beta I_e \frac{e^{-j\beta r}}{4\pi r} e^{j\beta z' \cos \theta} \cdot \sin \theta dz' \quad (8.15)$$

Using the superposition principle, the total far field is obtained as:

$$E_{\theta} = \int_{-l/2}^{l/2} dE_{\theta} \simeq j\eta\beta \frac{e^{-j\beta r}}{4\pi r} \cdot \sin \theta \cdot \int_{-l/2}^{l/2} I_{e(z')} e^{j\beta z' \cos \theta} dz' \quad (8.16)$$

The *first factor*

$$g(\theta) = j\eta\beta \frac{e^{-j\beta r}}{r} \sin \theta \quad (8.17)$$

is called the *element factor*. The element factor in this case is the far field produced by an infinitesimal dipole of unit current element $I \cdot l = 1$ (A · m). The *second factor*

$$f(\theta) = \int_{-l/2}^{l/2} I_{e(z')} e^{j\beta z' \cos \theta} dz' \quad (8.18)$$

is called the *space factor (or pattern factor, array factor)*. The pattern factor is dependent on the amplitude and phase distribution of the current at the antenna (the source distribution in space).

The element factor is well known, and is the same for any current element, provided the angle θ is always associated with the current-element axis.

For the specific current distribution described by (8.11), the pattern factor is:

$$f(\theta) = I_0 \cdot \left\{ \int_{-l/2}^0 \sin \left[\beta \left(\frac{l}{2} + z' \right) \right] e^{j\beta z' \cos \theta} dz' + \int_0^{l/2} \sin \left[\beta \left(\frac{l}{2} - z' \right) \right] e^{j\beta z' \cos \theta} dz' \right\} \quad (8.19)$$

The above integrals are solved having in mind that

$$\int \sin(a + b \cdot x) e^{cx} dx = \frac{e^{cx}}{b^2 + c^2} [c \sin(a + bx) - b \cos(a + bx)] \quad (8.20)$$

The far field of the finite-length dipole is obtained as:

$$E_\theta = g(\theta) \cdot f(\theta) = j\eta I_0 \frac{e^{-j\beta r}}{2\pi r} \left[\frac{\cos\left(\frac{\beta l}{2} \cos \theta\right) - \cos\left(\frac{\beta l}{2}\right)}{\sin \theta} \right], \quad (8.21)$$

$$H_\varphi = \frac{E_\theta}{\eta}$$

The amplitude pattern:

$$\bar{E}(\theta, \varphi) = \frac{\cos\left(\frac{\beta l}{2} \cos \theta\right) - \cos\left(\frac{\beta l}{2}\right)}{\sin \theta} \quad (8.22)$$

Patterns (in dB) for some dipole lengths $l \leq \lambda$:

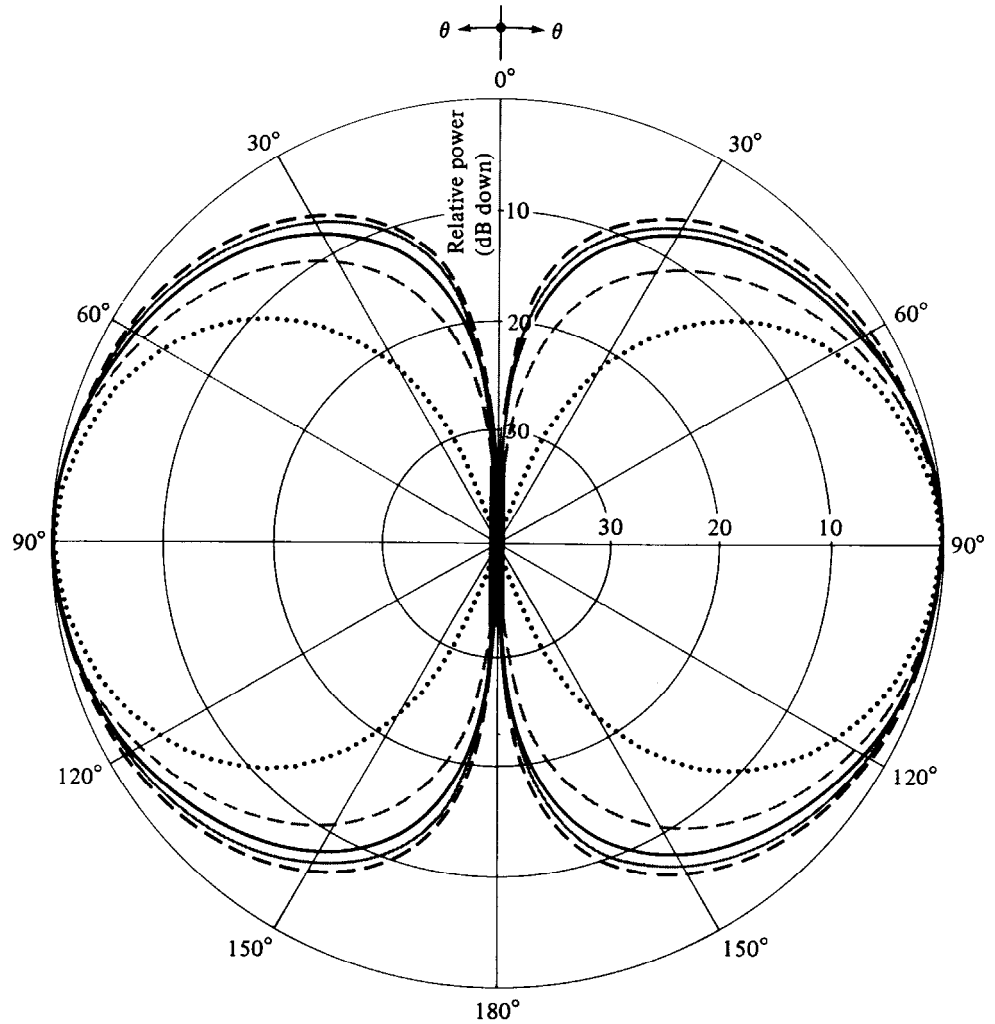

- $l \ll \lambda$
- $l = \lambda/4$
- $l = \lambda/2$
- · - · - $l = 3\lambda/4$
- $l = \lambda$

The pattern of the dipole $l = 1.25\lambda$

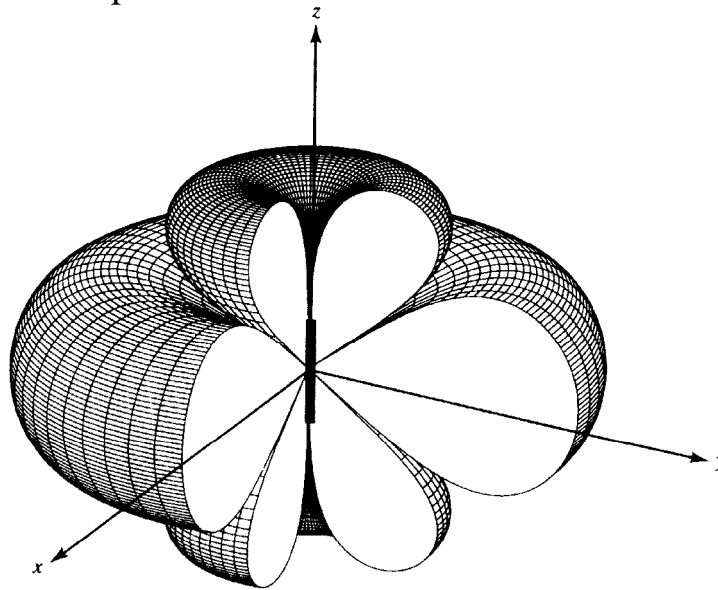

(a) Three-dimensional

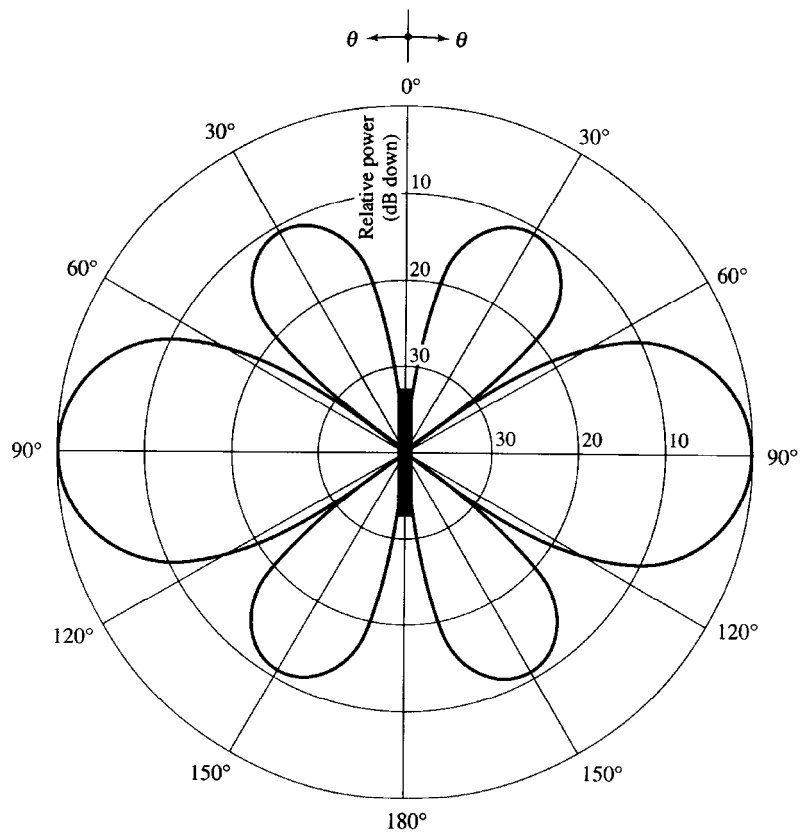

(b) Two-dimensional

The power pattern:

$$F(\theta, \varphi) = \left[\frac{\cos\left(\frac{\beta l}{2} \cos \theta\right) - \cos\left(\frac{\beta l}{2}\right)}{\sin \theta} \right]^2 \quad (8.23)$$

Note: The maximum of $F(\theta, \varphi)$ is not necessarily unity, but for $l < 2\lambda$ the major maximum is always at $\theta = 90^\circ$.

The radiated power

First, the average power flux density is calculated as:

$$\vec{P} = \hat{r} \cdot \frac{1}{2\eta} |E_\theta|^2 = \hat{r} \cdot \eta \frac{|I_0|^2}{8\pi^2 r^2} \left[\frac{\cos\left(\frac{\beta l}{2} \cos \theta\right) - \cos\left(\frac{\beta l}{2}\right)}{\sin \theta} \right]^2 \quad (8.24)$$

The total radiated power is given by the integral:

$$\Pi = \oiint \vec{P} d\vec{s} = \int_0^{2\pi} \int_0^\pi P \cdot r^2 \sin \theta d\theta d\varphi \quad (8.25)$$

$$\Pi = \eta \frac{|I_0|^2}{4\pi} \underbrace{\int_0^\pi \left[\frac{\cos\left(\frac{\beta l}{2} \cos \theta\right) - \cos\left(\frac{\beta l}{2}\right)}{\sin \theta} \right]^2 d\theta}_{\mathfrak{S}} \quad (8.26)$$

\mathfrak{S} is solved in terms of the cosine and the sine integrals:

$$\begin{aligned} \mathfrak{S} = & C + \ln(\beta l) - C_i(\beta l) + \frac{1}{2} \sin(\beta l) [S_i(2\beta l) - 2S_i(\beta l)] + \\ & + \frac{1}{2} \cos(\beta l) [C + \ln(\beta l) + C_i(2\beta l) - 2C_i(\beta l)] \end{aligned} \quad (8.27)$$

Here:

$C \approx 0.5772$ is the Euler's constant

$C_i(x) = \int_\infty^x \frac{\cos y}{y} dy = -\int_x^\infty \frac{\cos y}{y} dy$ is the cosine integral

$S_i(x) = \int_0^x \frac{\sin y}{y} dy$ is the sine integral.

So, the radiated power can be written as:

$$\Pi = \eta \frac{|I_0|^2}{4\pi} \cdot \mathfrak{S} \tag{8.28}$$

Radiation resistance:

$$R_r = \frac{2\Pi}{|I_0|^2} = \frac{\eta}{2\pi} \cdot \mathfrak{S} \tag{8.29}$$

Directivity:

$$D_0 = 4\pi \frac{U_{\max}}{\Pi} = 4\pi \frac{F_{\max}}{\int_0^\pi \int_0^{2\pi} F(\theta, \varphi) \sin \theta d\theta d\varphi} \tag{8.30}$$

where:

$$F(\theta, \varphi) = \left[\frac{\cos\left(\frac{\beta l}{2} \cos \theta\right) - \cos\left(\frac{\beta l}{2}\right)}{\sin \theta} \right]^2 \text{ is the power pattern (see (8.23)).}$$

Finally,

$$D_0 = \frac{2F_{\max}}{\mathfrak{S}} \tag{8.31}$$

Input resistance

The radiation resistance given in (8.29) corresponds to the radiated power but it is not equal to the input resistance because the current at the dipole center (if its center is the feed point) is not necessarily of the maximum amplitude. If the dipole is lossless, the input power is equal to the radiated one:

$$\frac{|I_{in}|^2}{2} R_{in} = \frac{|I_0|^2}{2} R_r \tag{8.32}$$

According to the sinusoidal distribution assumed in (8.11), the current at the center of the dipole ($z' = 0$) is:

$$I_{in} = I_0 \sin\left(\beta \frac{l}{2}\right) \tag{8.33}$$

$$\Rightarrow R_{in} = \frac{R_r}{\sin^2\left(\beta \frac{l}{2}\right)} \tag{8.34}$$

3. Half-wavelength dipole

This is a classical and widely used thin wire antenna: $l = \frac{\lambda}{2}$

$$\begin{aligned} E_{\theta} &\approx j\eta \frac{I_0 e^{-j\beta r}}{2\pi r} \cdot \frac{\cos\left(\frac{\pi}{2} \cos\theta\right)}{\sin\theta} \\ H_{\phi} &= \frac{E_{\theta}}{\eta} \end{aligned} \tag{8.35}$$

Radiated power flow density:

$$P = \frac{\eta}{2} |E_{\theta}|^2 = \eta \frac{|I_0|^2}{8\pi^2 r^2} \underbrace{\left[\frac{\cos\left(\frac{\pi}{2} \cos\theta\right)}{\sin\theta} \right]^2}_{F(\theta) - \text{normalized power pattern}} \approx \eta \frac{|I_0|^2}{8\pi^2 r^2} \sin^3\theta \tag{8.36}$$

Radiation intensity:

$$U = r^2 P = \eta \frac{|I_0|^2}{8\pi^2} \underbrace{\left[\frac{\cos\left(\frac{\pi}{2} \cos\theta\right)}{\sin\theta} \right]^2}_{F(\theta) - \text{normalized power pattern}} \approx \eta \frac{|I_0|^2}{8\pi^2} \sin^3\theta \tag{8.37}$$

3-D power pattern (not in dB) of the half-wavelength dipole:

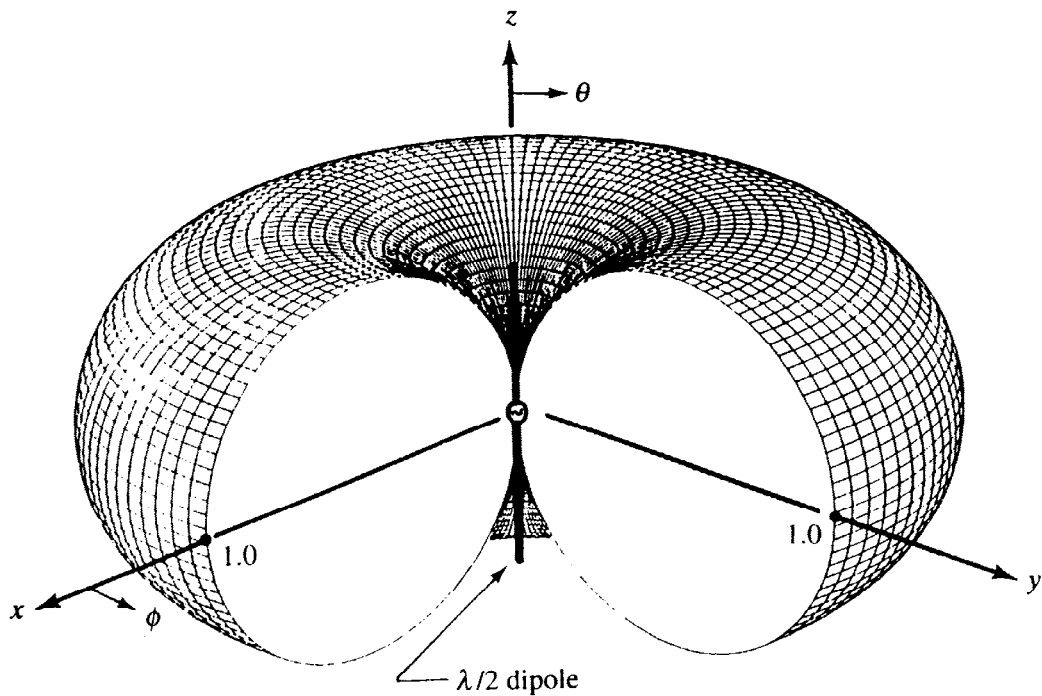

Radiated power

The radiated power of the half-wavelength dipole is, of course, a special case of the integral in (8.26).

$$\begin{aligned} \Pi &= \eta \frac{|I_0|^2}{4\pi} \int_0^\pi \frac{\cos^2\left(\frac{\pi}{2} \cos \theta\right)}{\sin \theta} d\theta \\ \Pi &= \eta \frac{|I_0|^2}{8\pi} \underbrace{\int_0^{2\pi} \frac{1 - \cos y}{y} dy}_{\mathfrak{S}}, \end{aligned} \tag{8.38}$$

$$\mathfrak{S} = 0.5772 + \ln(2\pi) - C_i(2\pi) \approx 2.435$$

$$\Rightarrow \Pi = 2.435 \frac{\eta}{8\pi} |I_0|^2 = 36.525 |I_0|^2 \tag{8.39}$$

Radiation resistance

$$R_r = \frac{2\Pi}{|I_0|^2} \approx 73 \ \Omega \tag{8.40}$$

Directivity

$$D_0 = 4\pi \frac{U_{\max}}{\Pi} = 4\pi \frac{U_{/\theta=90^\circ}}{\Pi} = \frac{4}{\mathfrak{S}} = \frac{4}{2.435} = 1.643 \quad (8.41)$$

Maximum effective area

$$A_e = \frac{\lambda^2}{4\pi} D_0 \approx 0.13\lambda^2 \quad (8.42)$$

Input resistance

Since $l = \lambda/2$,

$$R_{in} = R_r \approx 73 \ \Omega \quad (8.43)$$

The imaginary part of the input impedance is approximately $\approx +j42.5 \ \Omega$. To acquire maximum power transfer, this reactance has to be removed by matching (that is shortening) the dipole:

- thick dipole $l \approx 0.47\lambda$
- thin dipole $l \approx 0.48\lambda$

The input impedance of the dipole is very frequency sensitive; in other words, it depends strongly on the ratio l/λ . This is to be expected from a resonant structure operating near the resonance, such as the half-wavelength dipole. It should be also kept in mind that the input impedance is influenced in a non-negligible way by the capacitance associated with the physical junction to the transmission line. The structure used to support the antenna, if any, can also influence the input impedance. That is why the curves that are given below describing the antenna impedance should be considered just representative of a typical behaviour.

Below, measurement results for the input impedance of a dipole are given.

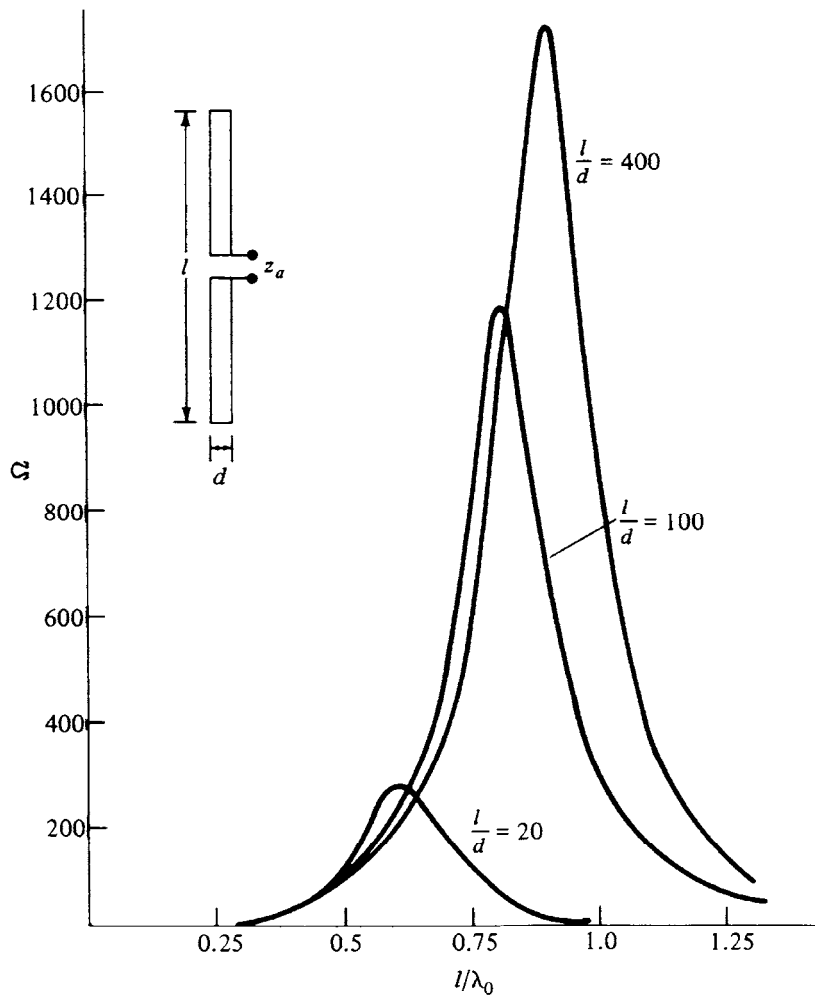

Input resistance of dipole antenna

† G. H. Brown, and O. M. Woodward, Jr., “Experimentally Determined Impedance Characteristics of Cylindrical Antennas,” *Proc. IRE*, vol. 33, 1945, pp. 257–262.

Note the strong influence of the dipole diameter on its resonant properties.

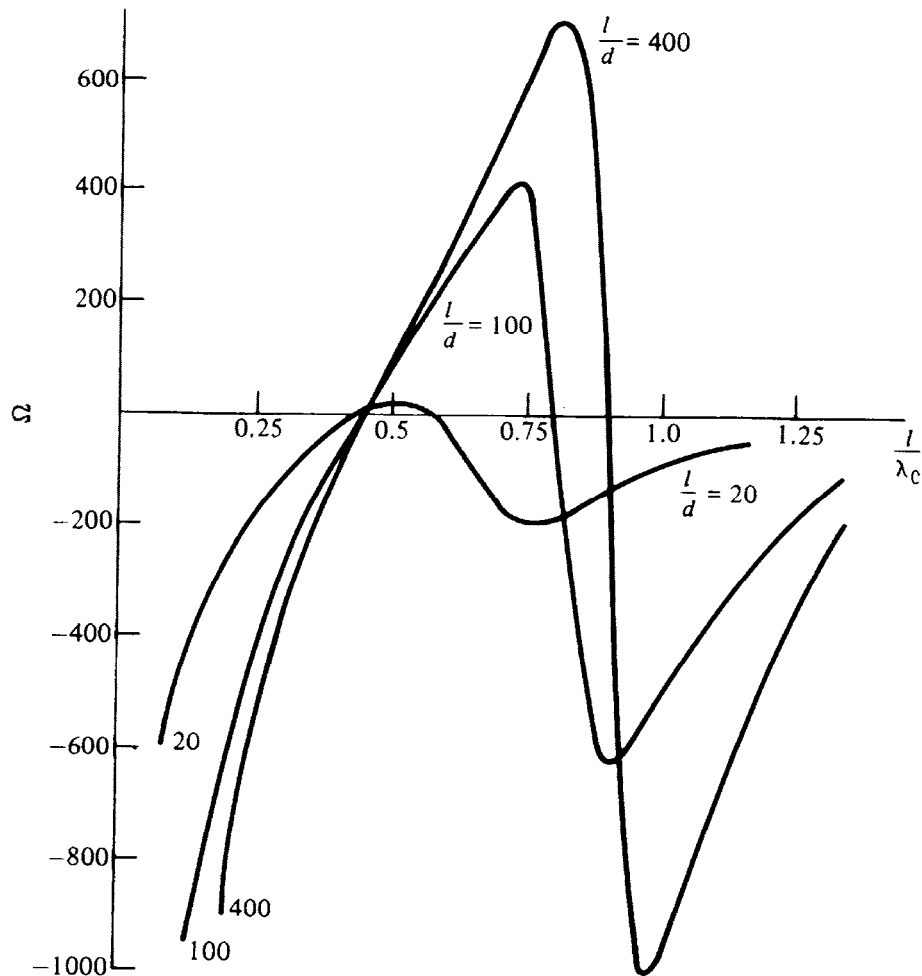

Input reactance of a dipole antenna

One can calculate the input resistance as a function of l/λ using equations (8.29) and (8.34). These equations, however, are valid only for infinitesimally thin dipoles. Besides, it is important to compute the exact reactance, too. In practice, dipoles are most often tubular, and they have some finite diameter d . General-purpose numerical methods (such as the *Method of Moments* or *FDTD*) are used to calculate the antenna impedance. When finite-thickness wire antennas are to be analyzed and no assumption is made for the current distribution along the wire, the MoM is applied to the classical Pocklington's equation or to its variation, the Hallen's equation. A classical method producing closed form solutions for the self-impedance and the mutual impedance of straight-wire antennas is the *induced emf method*, which will be discussed later. The induced emf method does assume sinusoidal current distribution.

4. Method of images – revision

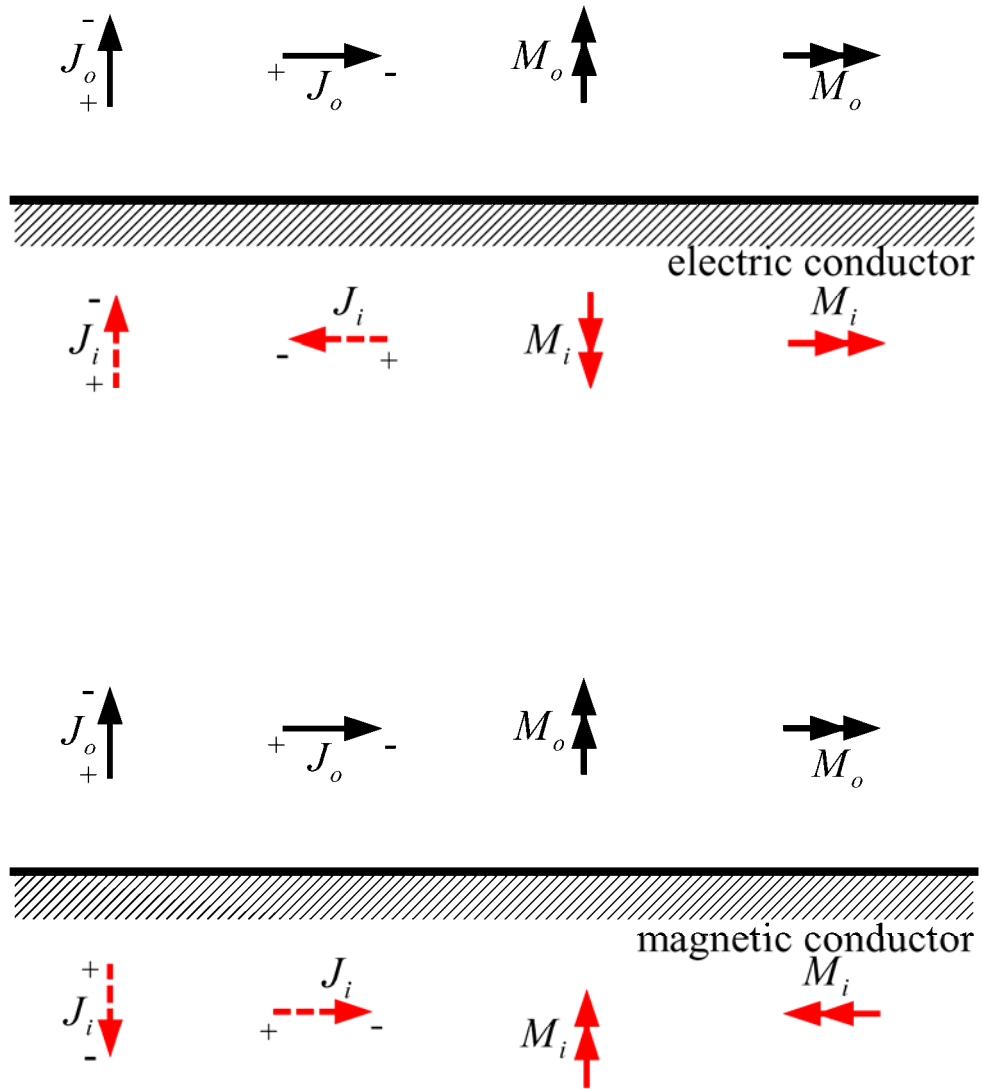

5. Vertical electric current element above perfect conductor

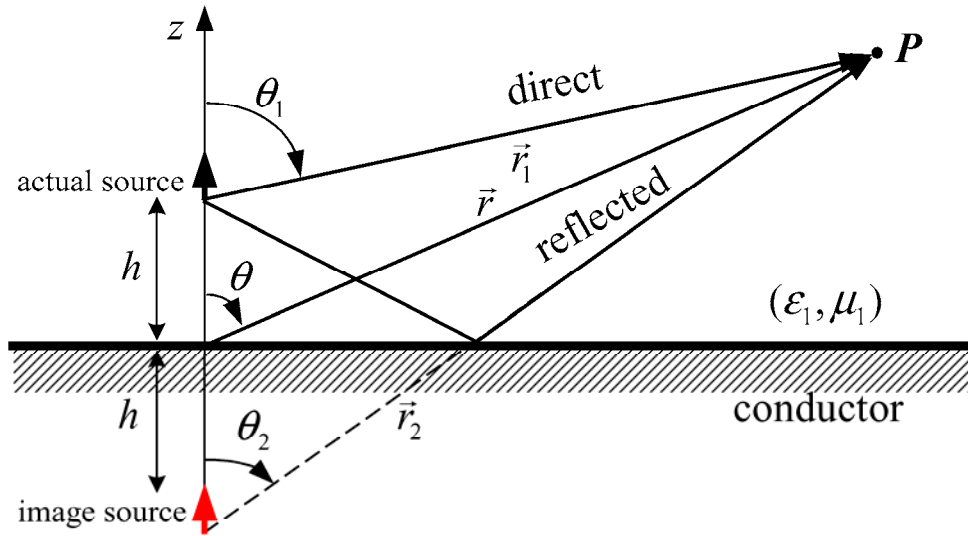

The field at the observation point P is a superposition of the fields of the actual source and the image source, both radiating in a homogeneous medium of constitutive parameters (ϵ_1, μ_1) . The actual source is a current element $(I_0 \Delta l)$ (infinitesimal dipole).

$$E_{\theta}^d = j\eta\beta(I_0 \Delta l) \frac{e^{-j\beta r_1}}{4\pi r_1} \cdot \sin \theta_1 \tag{8.44}$$

$$E_{\theta}^r = j\eta\beta(I_0 \Delta l) \frac{e^{-j\beta r_2}}{4\pi r_2} \cdot \sin \theta_2$$

Expressing the distances $|\vec{r}_1|$ and $|\vec{r}_2|$ in terms of $|\vec{r}|$ and h (using the cosine theorem) gives:

$$\begin{aligned} r_1 &= \sqrt{r^2 + h^2 - 2rh \cos \theta} \\ r_2 &= \sqrt{r^2 + h^2 - 2rh \cos(\pi - \theta)} \end{aligned} \tag{8.45}$$

We shall use the binomial expansion of r_1 and r_2 to obtain approximations of the amplitude and the phase terms, which would simplify the evaluation of the total far field and the VP integral.

For the amplitude term:

$$\frac{1}{r_1} \simeq \frac{1}{r_2} \simeq \frac{1}{r} \tag{8.46}$$

For the phase term, we shall use a second order approximation (see also the geometrical interpretation below).

$$\begin{aligned} r_1 &\simeq r - h \cos \theta \\ r_2 &\simeq r + h \cos \theta \end{aligned} \tag{8.47}$$

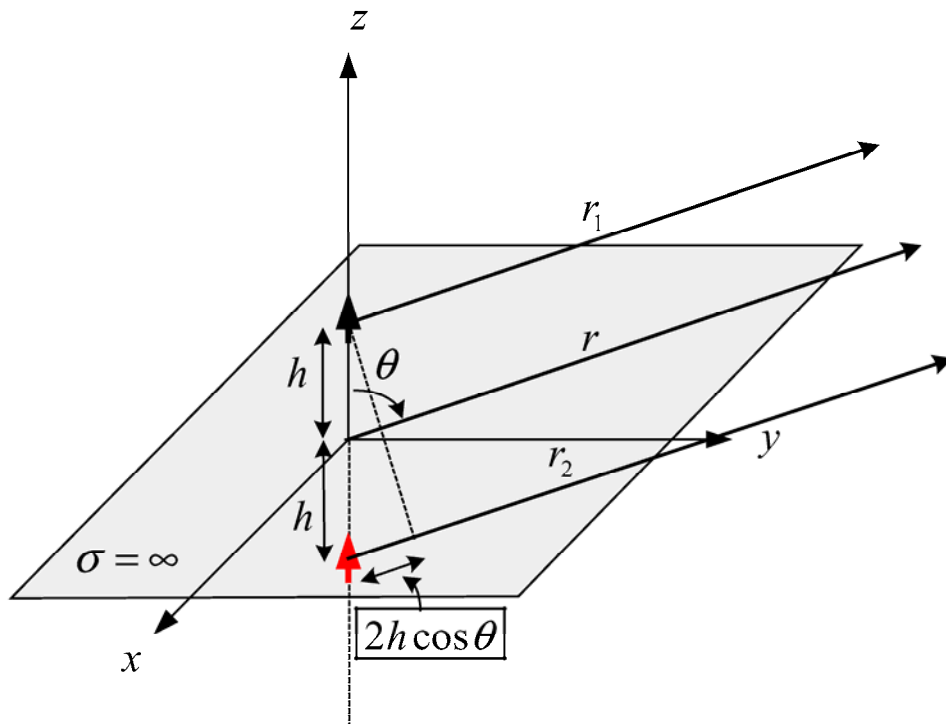

The total far field is:

$$E_\theta = E_\theta^d + E_\theta^r \tag{8.48}$$

$$E_\theta = j\eta\beta \frac{(I_0\Delta l)}{4\pi r} \cdot \sin \theta \left[e^{-j\beta(r-h\cos\theta)} + e^{-j\beta(r+h\cos\theta)} \right] \tag{8.49}$$

$$\boxed{\begin{aligned} E_\theta &\simeq \underbrace{j\eta\beta(I_0\Delta l) \frac{e^{-j\beta r}}{4\pi r} \sin \theta}_{g(\theta)} \cdot \underbrace{[2 \cos(\beta h \cos \theta)]}_{f(\theta)}, \quad z \geq 0 \\ E_\theta &= 0, \quad z < 0 \end{aligned}} \tag{8.50}$$

Again, it should be noted that the far field expression can be decomposed into two factors: the field of the elementary source $g(\theta)$ and the pattern factor (also array factor) $f(\theta)$.

The normalized power pattern is:

$$F(\theta) = [\sin \theta \cdot \cos(\beta h \cos \theta)]^2 \tag{8.51}$$

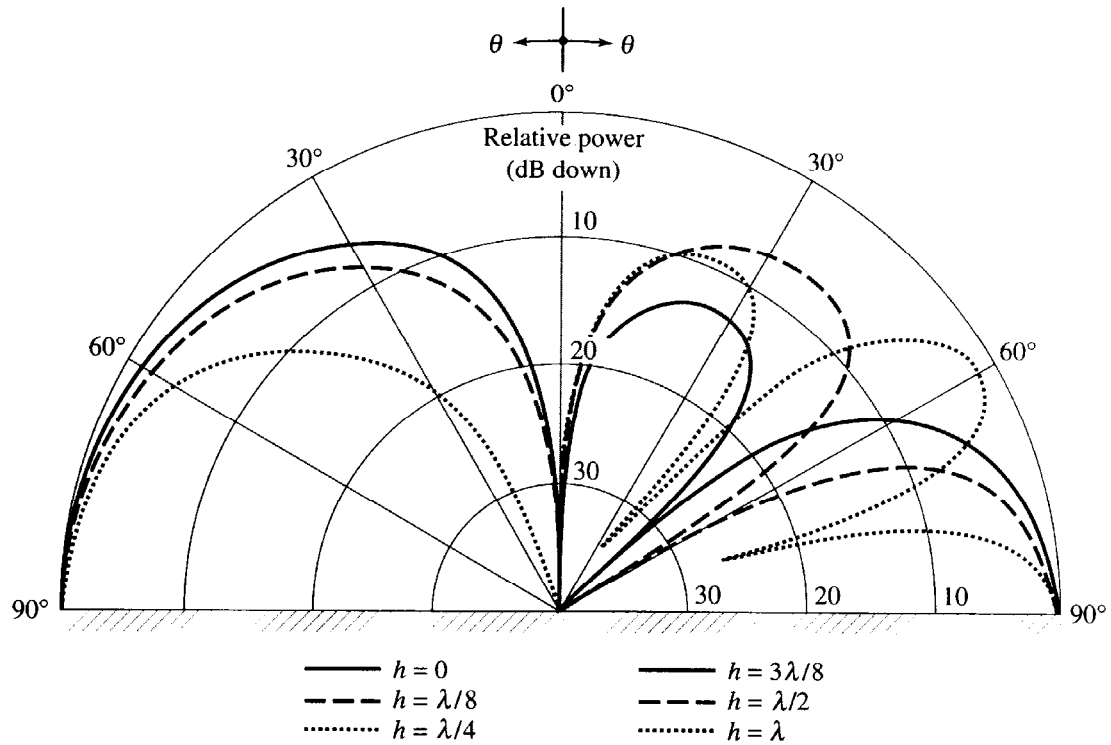

Elevation plane patterns of a vertical infinitesimal electric dipole for different height above a perfectly conducting plane.

As the vertical dipole is moved further away from the infinite conducting (ground) plane, more and more lobes are introduced in the power pattern. This effect is called *scalloping* of the pattern. The number of lobes is

$$n = \text{nint} \left(\frac{2h}{\lambda} + 1 \right)$$

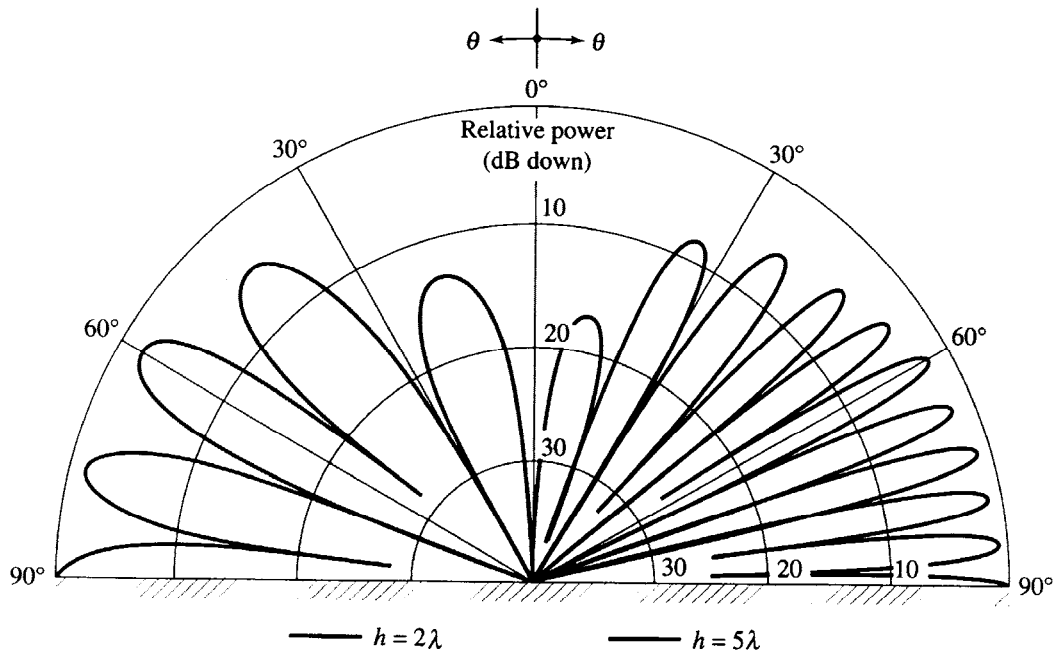

Total radiated power

$$\begin{aligned}\Pi &= \oiint \vec{P} d\vec{s} = \frac{1}{2\eta} \int_0^{2\pi} \int_0^{\pi/2} |E_\theta|^2 r^2 \sin\theta d\theta d\varphi \\ \Pi &= \frac{\pi}{\eta} \int_0^{\pi/2} |E_\theta|^2 r^2 \sin\theta d\theta\end{aligned}\quad (8.52)$$

$$\begin{aligned}\Pi &= \eta\beta^2 (I_0\Delta l)^2 \int_0^{\pi/2} \sin^2\theta \cdot \cos^2(\beta h \cos\theta) d\theta \\ \Pi &= \pi\eta \left(\frac{I_0\Delta l}{\lambda}\right)^2 \left[\frac{1}{3} - \frac{\cos(2\beta h)}{(2\beta h)^2} + \frac{\sin(2\beta h)}{(2\beta h)^3} \right]\end{aligned}\quad (8.53)$$

- As $\beta h \rightarrow 0$, the radiated power of the vertical dipole approaches twice the value of the radiated power of a dipole of the same length in free space.
- As $\beta h \rightarrow \infty$, the radiated power of both dipoles becomes the same.

Radiation resistance

$$R_r = \frac{2\Pi}{|I_0|^2} = 2\pi\eta \left(\frac{\Delta l}{\lambda}\right)^2 \left[\frac{1}{3} - \frac{\cos(2\beta h)}{(2\beta h)^2} + \frac{\sin(2\beta h)}{(2\beta h)^3} \right]\quad (8.54)$$

- As $\beta h \rightarrow 0$, the radiation resistance of the vertical dipole approaches twice the value of the radiation resistance of a dipole of the same length in free space:

$$R_{in}^{mp} = \frac{1}{2} R_{in}^{dp}, \quad \beta h = 0\quad (8.55)$$

- As $\beta h \rightarrow \infty$, the radiation resistance of both dipoles becomes the same.

Radiation intensity

$$U = r^2 P = r^2 \frac{|E_\theta|^2}{2\eta} = \frac{\eta}{2} \left(\frac{I_0 \Delta l}{\lambda} \right)^2 \sin^2 \theta \cos^2 (\beta h \cos \theta) \quad (8.56)$$

The maximum of $U(\theta)$ occurs at $\theta = \pi/2$ (except for $\beta h \rightarrow \infty$):

$$U_{\max} = \frac{\eta}{2} \left(\frac{I_0 \Delta l}{\lambda} \right)^2 \quad (8.57)$$

This value is 4 times greater than U_{\max} of a free-space dipole.

Maximum directivity

$$D_0 = 4\pi \frac{U_{\max}}{\Pi} = \frac{2}{\frac{1}{3} - \frac{\cos(2\beta h)}{(2\beta h)^2} + \frac{\sin(2\beta h)}{(2\beta h)^3}} \quad (8.58)$$

If $\beta h = 0$, $D_0 = 3$, which is twice the max. directivity of a free-space current element ($D_0^{id} = 1.5$) The maximum of D_0 occurs when $\beta h = 2.881$ ($h = 0.4585\lambda$). Then, $D_0 = 6.566$ $_{|\beta h=2.881}$.

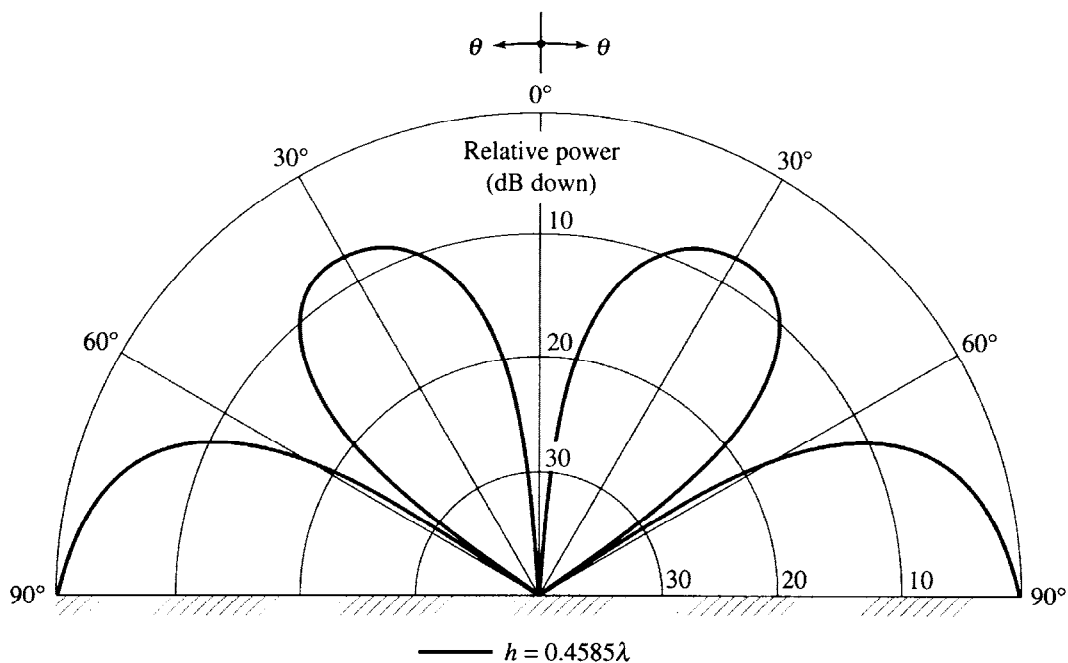

6. Monopoles

A monopole is a dipole that has been divided into half at its center feed point and fed against a ground plane. It is normally $\lambda/4$ long (a *quarter-wavelength monopole*), but it might be shorter when space restrictions dictate shorter lengths. Then, the monopole is a *small monopole* whose counterpart is the *small dipole* (see Section 1, this Lecture). Its current has linear distribution with its maximum at the feed point, and its null at the monopole's edge.

The vertical monopole is extensively used for AM broadcasting ($f=500$ to 1500 kHz, $\lambda=200$ to 600 m), because it is the shortest most efficient antenna at these frequencies, as well as because vertically polarized waves suffer less attenuation at close to the ground propagation. Vertical monopoles are widely used as base-station antennas in mobile communications, too.

Monopoles at base stations and radiobroadcast stations are supported by suitable towers and guy wires. The guy wires must be separated into short enough ($\leq \lambda/8$) pieces, which are insulated from each other to suppress any parasitic currents. Special care is taken for proper grounding of the monopole. Usually multiple radial wire rods, each $0.25 - 0.35\lambda$ long, are buried at the monopole base in the ground to simulate perfect ground plane, so that the pattern approximates closely the theoretical one, i.e. the pattern of the $\lambda/2$ -dipole. Losses in the ground plane cause undesirable deformation of the pattern as shown below for an infinitesimal dipole above an imperfect ground plane.

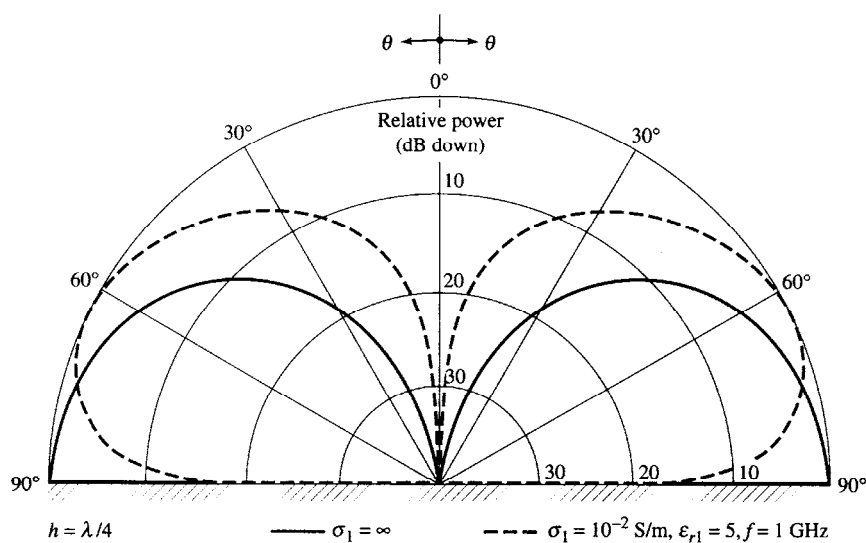

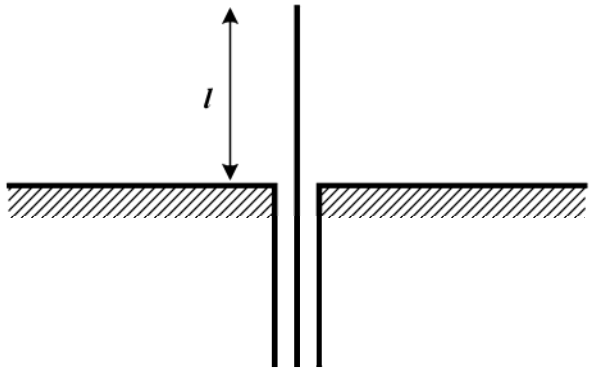

Monopole fed against a large solid ground plane

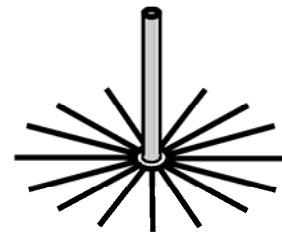

Practical monopole with radial wires to simulate perfect ground

Several important conclusions follow from the image theory and the discussion in Section 5.

- The field distribution in the upper half-space is the same as that of the respective free-space dipole
- The currents and the charges on a monopole are the same as on the upper half of its dipole counterpart, but the terminal voltage is only half that of the dipole. The input impedance of a monopole is therefore only half that of the respective dipole:

$$Z_{in}^{mp} = \frac{1}{2} Z_{in}^{dp} \quad (8.59)$$

(See also (8.55).)

- The total radiated power of a monopole is half the power radiated by its dipole counterpart, since it radiates in half-space (but its field is the same). As a result, the beam solid angle of the monopole is half that of the respective dipole and its directivity is twice the directivity of the dipole.

$$D_0^{mp} = \frac{4\pi}{\Omega_A^{mp}} = \frac{4\pi}{\frac{1}{2}\Omega_A^{dp}} = 2D_0^{dp} \quad (8.60)$$

The quarter-wavelength monopole

This is a straight wire of length $l = \lambda/4$ mounted over a ground plane. From the discussion above, it can be expected that the quarter-wavelength monopole should be very similar to the half-wavelength dipole in the hemisphere above the ground plane.

- Its radiation pattern is the same as that of a free-space $\lambda/2$ -dipole, only that it is non-zero only for $0^\circ < \theta \leq 90^\circ$ (above ground).
- The field expressions are the same as those of the $\lambda/2$ -dipole.
- The radiated power of the $\lambda/4$ -monopole is half that of the $\lambda/2$ -dipole.
- The radiation resistance of the $\lambda/4$ -monopole is half that of the $\lambda/2$ -dipole: $Z_{in}^{mp} = 0.5Z_{in}^{dp} = 0.5(73 + j42.5) = 36.5 + j21.25, \Omega$.
- The directivity of the $\lambda/4$ -monopole is:

$$D_0^{mp} = 2D_0^{dp} = 2 \cdot 1.643 = 3.286$$

Some approximate formulas for rapid calculations of the input resistance of a dipole and the respective monopole:

$$\text{Let } \left\{ \begin{array}{l} G = \frac{\beta l}{2} = \pi \frac{l}{\lambda}, \text{ for dipole} \\ G = \beta l = 2\pi \frac{l}{\lambda}, \text{ for monopole} \end{array} \right.$$

Then,

- if $0 < G < \frac{\pi}{4}$

$$\left\{ \begin{array}{l} R_{in} = 20G^2, \text{ dipole} \\ R_{in} = 10G^2, \text{ monopole} \end{array} \right.$$

- if $\frac{\pi}{4} < G < \frac{\pi}{2}$

$$\left| \begin{array}{l} R_{in} = 24.7G^{2.5} \text{ , dipole} \\ R_{in} = 12.35G^{2.5} \text{ , monopole} \end{array} \right.$$

- if $\frac{\pi}{2} < G < 2$

$$\left| \begin{array}{l} R_{in} = 11.14G^{4.17} \text{ , dipole} \\ R_{in} = 5.57G^{4.17} \text{ , monopole} \end{array} \right.$$

7. Horizontal current element above a perfectly conducting plane

The analysis is analogous to that of a vertical current element above a ground plane. The difference arises in the element factor $g(\theta)$ because of the horizontal orientation of the current element. Let's assume that the current element is oriented along the y -axis, and the angle between \vec{r} and the dipole's axis (y -axis) is ψ .

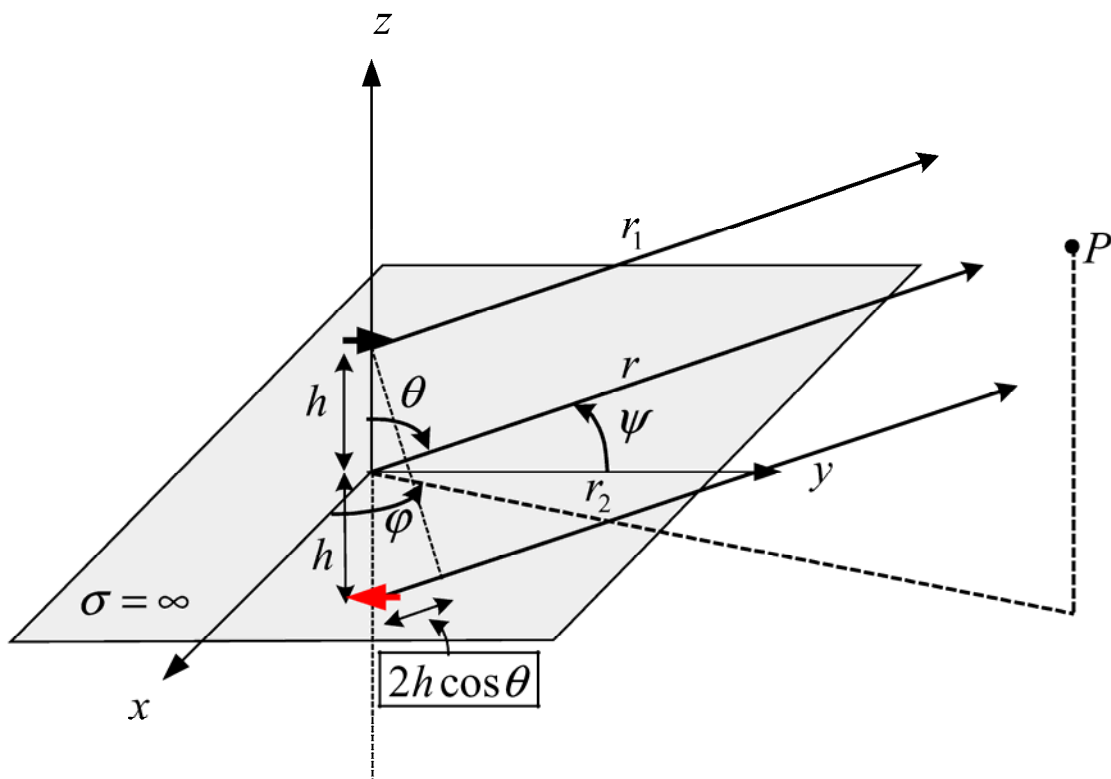

$$\vec{E}(P) = \vec{E}^d(P) + \vec{E}^r(P) \tag{8.61}$$

$$E_\psi^d = j\eta\beta(I_0\Delta l) \frac{e^{-j\beta r_1}}{4\pi r_1} \sin\psi \tag{8.62}$$

$$E_\psi^r = -j\eta\beta(I_0\Delta l) \frac{e^{-j\beta r_2}}{4\pi r_2} \sin\psi \tag{8.63}$$

One can express the angle ψ in terms of (θ, φ) .

$$\begin{aligned} \cos\psi &= \hat{y} \cdot \hat{r} = \hat{y} \cdot (\hat{x} \sin\theta \cos\varphi + \hat{y} \sin\theta \sin\varphi + \hat{z} \cos\theta) \\ \Rightarrow \cos\psi &= \sin\theta \sin\varphi \\ \Rightarrow \sin\psi &= \sqrt{1 - \sin^2\theta \sin^2\varphi} \end{aligned} \tag{8.64}$$

The far-field approximations are:

$$\left. \begin{aligned} \frac{1}{r_1} &= \frac{1}{r_2} = \frac{1}{r}, \text{ for the amplitude term} \\ \left. \begin{aligned} r_1 &\approx r - h \cos\theta \\ r_2 &\approx r + h \cos\theta \end{aligned} \right\} \text{ for the phase term} \end{aligned} \right\}$$

Substituting the far-field approximations and equations (8.62), (8.63), (8.64) in the total field expression (8.61) yields:

$$E_\psi(\theta, \varphi) = \underbrace{j\eta\beta(I_0\Delta l) \frac{e^{-j\beta r}}{4\pi r}}_{\text{element factor } g(\theta, \varphi)} \sqrt{1 - \sin^2\theta \sin^2\varphi} \underbrace{\left[2j \sin(\beta h \cos\theta) \right]}_{\text{array factor } f(\theta, \varphi)} \tag{8.65}$$

The normalized pattern

$$F(\theta, \varphi) = (1 - \sin^2 \theta \sin^2 \varphi) \cdot \sin^2 (\beta h \cos \theta) \tag{8.66}$$

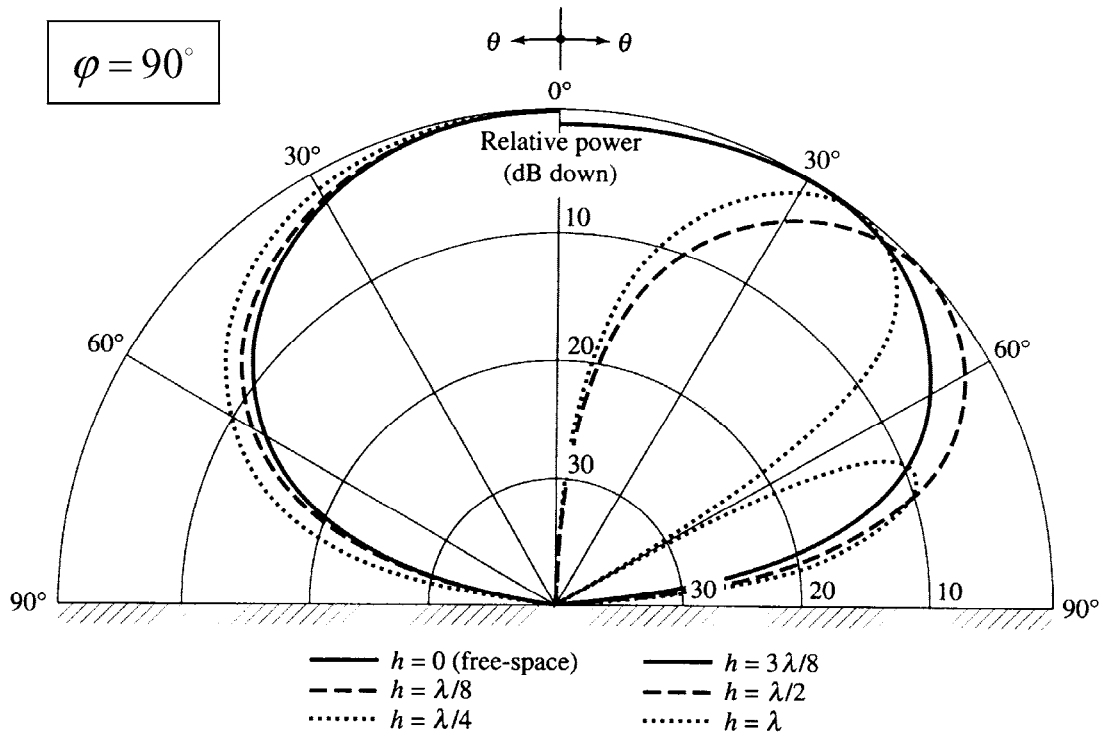

As the height increases beyond a wavelength ($h > \lambda$), scalloping appears with the number of lobes being:

$$n = \text{nint} \left(2 \frac{h}{\lambda} \right) \tag{8.67}$$

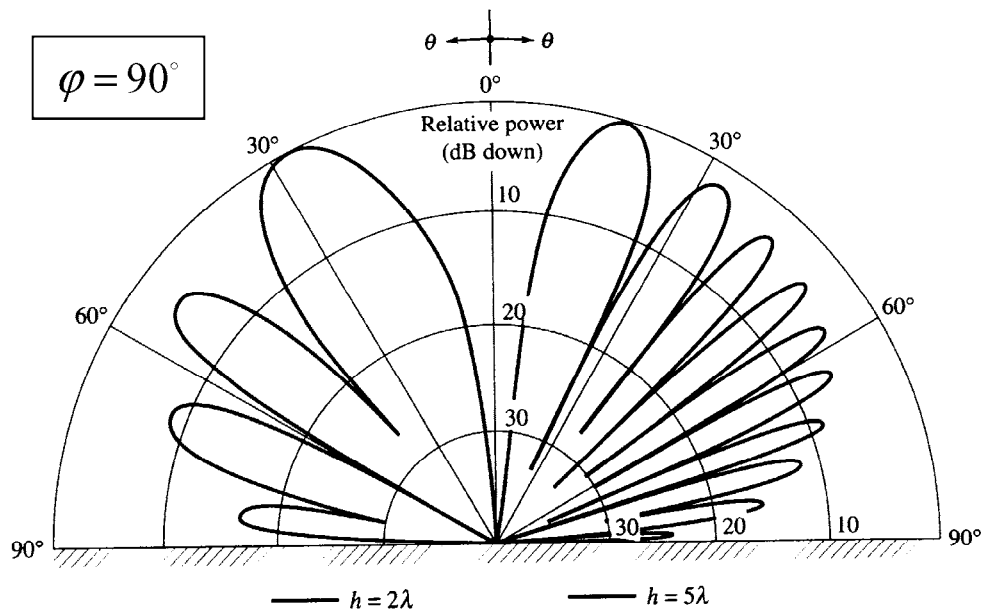

Following a procedure similar to that of the vertical dipole, the radiated power and the radiation resistance of the horizontal dipole can be found.

$$\Pi = \frac{\pi}{2} \eta \left(\frac{I_0 \Delta l}{\lambda} \right)^2 \underbrace{\left[\frac{2}{3} - \frac{\sin(2\beta h)}{2\beta h} - \frac{\cos(2\beta h)}{(2\beta h)^2} + \frac{\sin(2\beta h)}{(2\beta h)^3} \right]}_{R(\beta h)} \quad (8.68)$$

$$R_r = \pi \eta \left(\frac{\Delta l}{\lambda} \right)^2 \cdot R(\beta h) \quad (8.69)$$

By expanding the sine and the cosine functions into series, it can be shown that for small values of (βh) the following approximation holds:

$$R_r /_{\beta h \rightarrow 0} \simeq \frac{32\pi^2}{15} \left(\frac{h}{\lambda} \right)^2 \quad (8.70)$$

It is also obvious that if $h = 0$, then $R_r = 0$ and $\Pi = 0$. This is to be expected because the dipole is short-circuited by the ground plane.

Radiation intensity

$$U = \frac{r^2}{2\eta} |\vec{E}_\psi|^2 = \frac{\eta}{2} \left(\frac{I_0 \Delta l}{\lambda} \right)^2 (1 - \sin^2 \theta \sin^2 \varphi) \sin^2(\beta h \cos \theta) \quad (8.71)$$

The maximum value of (8.71) depends on whether (βh) is less than $\pi/2$ or greater:

- If $\beta h \leq \frac{\pi}{2} \left(h \leq \frac{\lambda}{4} \right)$

$$U_{\max} = \frac{\eta}{2} \left(\frac{I_0 \Delta l}{\lambda} \right)^2 \sin^2(\beta h) /_{\theta=0} \quad (8.72)$$

- If $\beta h > \frac{\pi}{2} \left(h > \frac{\lambda}{4} \right)$

$$U_{\max} = \frac{\eta}{2} \left(\frac{I_0 \Delta l}{\lambda} \right)^2 /_{\theta=\arccos\left(\frac{\pi}{2\beta h}\right), \varphi=0} \quad (8.73)$$

Maximum directivity

For small βh , $D_0 = 7.5 \left(\frac{\sin(\beta h)}{\beta h} \right)^2$