

RW4HFN Clip Antenna for 145 and 435- MHz

By: Igor Vakhreev, RW4HFN

It is very simple antenna that has shape of a paper clip can work at 145 and 430- MHz. **Figure 1** shows design of the antenna.

Figure 2 shows Z of Clip antenna for 145/435- MHz at 145- MHz band. **Figure 3** shows SWR of Clip antenna for 145/435- MHz at 145- MHz band. **Figure 4** shows DD of Clip antenna for 145/435- MHz at 145- MHz band.

Figure 5 shows Z of Clip antenna for 145/435- MHz at 435- MHz band. **Figure 6** shows SWR of Clip antenna for 145/435- MHz at 435- MHz band. **Figure 7** shows DD of Clip antenna for 145/435- MHz at 435- MHz band.

73! de RW4HFN

MMANA files for Clip Antenna made of wire in diameter 4. 6 and 8- mm may be downloaded at:

http://www.antentop.org/024/RW4HFN_Clip_024.htm

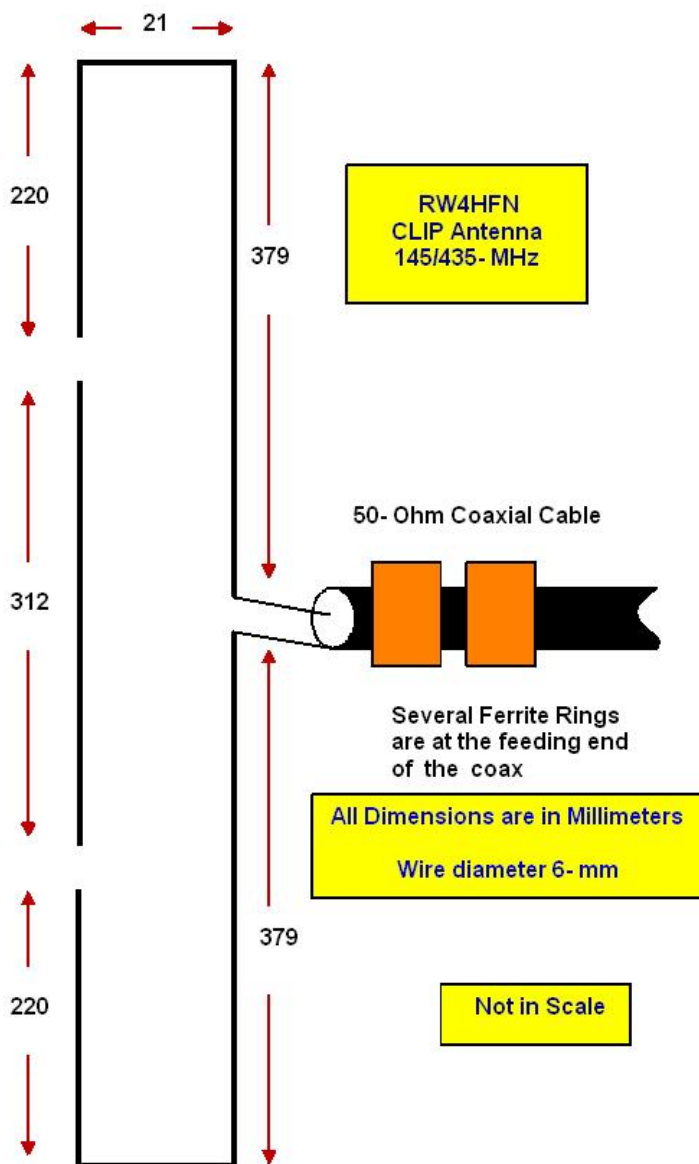

Figure 1 Clip antenna for 145/435- MHz Band

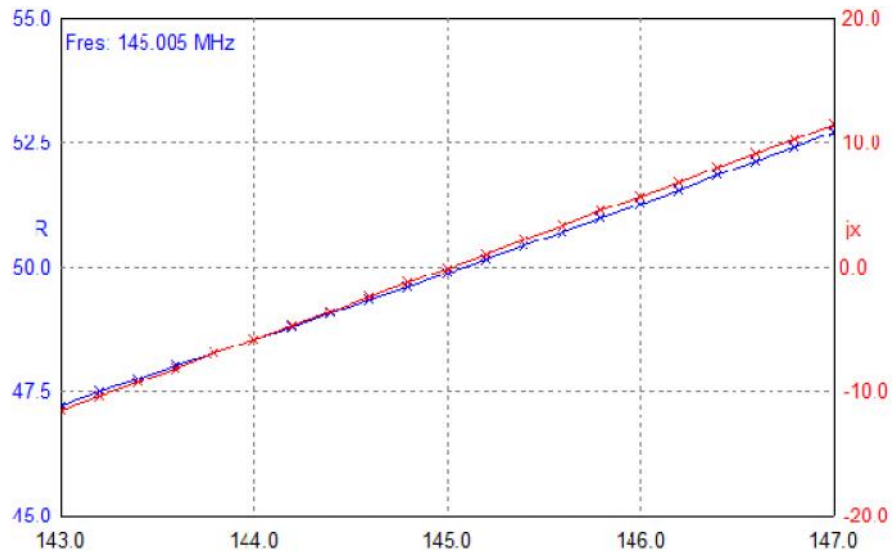

Figure 2 Z of Clip antenna for 145/435- MHz at 145- MHz band

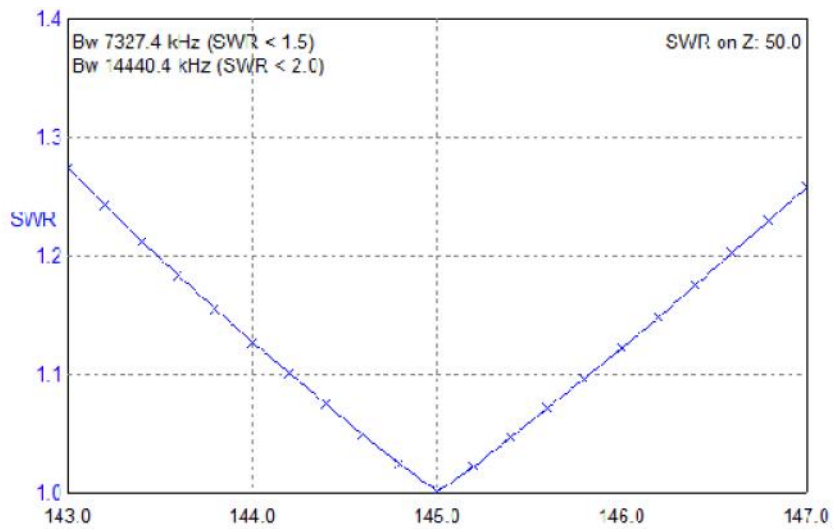

Figure 3 SWR of Clip antenna for 145/435- MHz at 145- MHz band

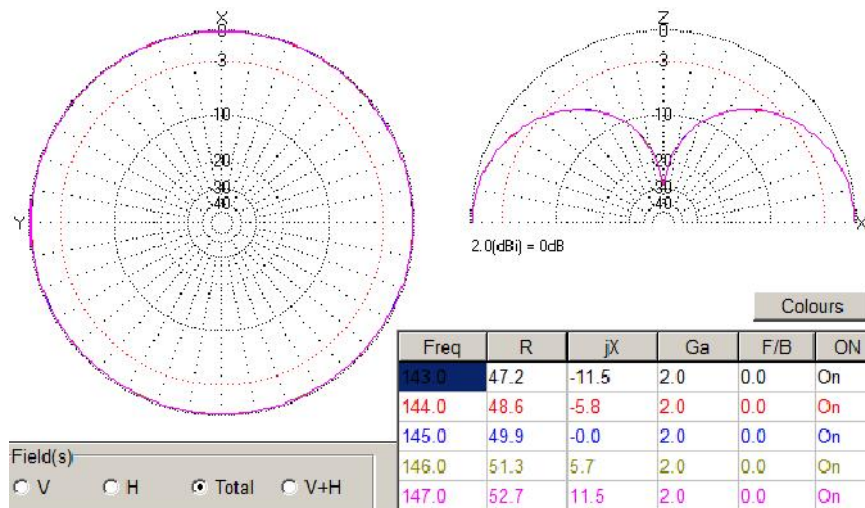

Figure 4 DD of Clip antenna for 145/435- MHz at 145- MHz band

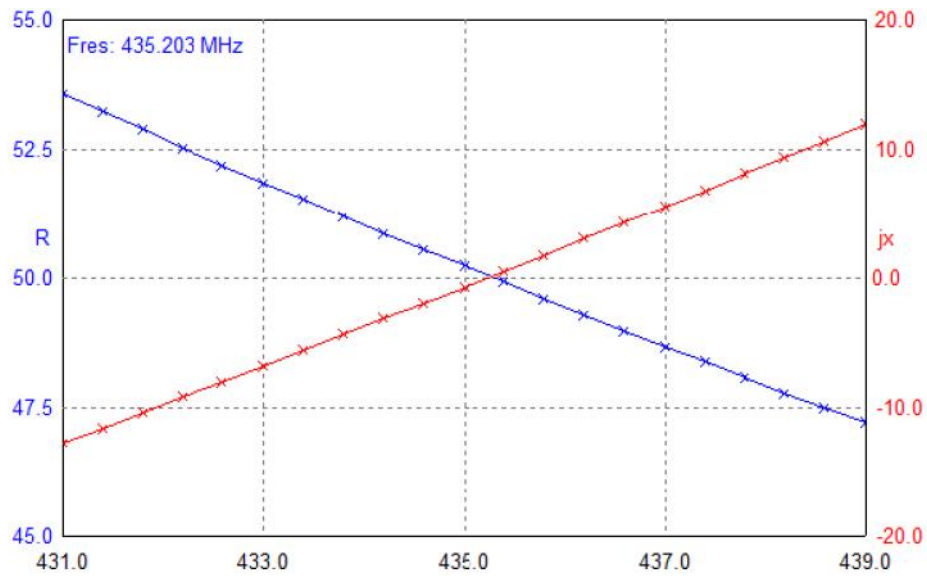

Figure 5 Z of Clip antenna for 145/435- MHz at 435- MHz band

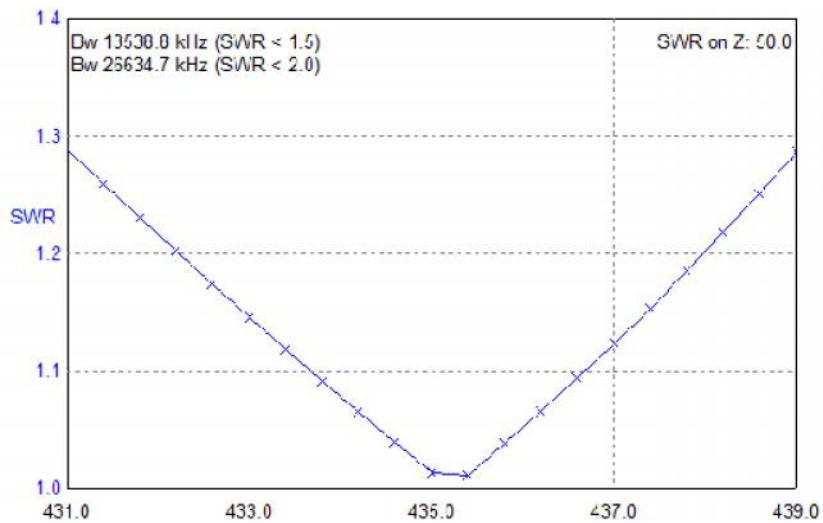

Figure 6 SWR of Clip antenna for 145/435- MHz at 435- MHz band

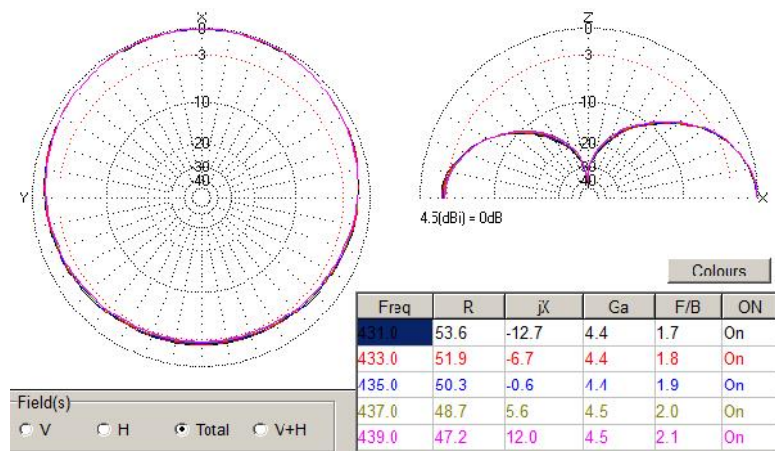

Figure 7 DD of Clip antenna for 145/435- MHz at 435- MHz band